

HW

MAN

D 140 n 5500 - 9500
D 180 n 4300 - 7400

D	B	d	T	Z	V	COD.
140	4:7.5	30	22	8	4	K408140430
140	4:7.5	31.75	22	8	4	K408140431
140	4:7.5	35	22	8	4	K408140435
140	4:7.5	40	22	8	4	K408140440
140	4:7.5	50	22	8	4	K408140450
180	4:7.5	30	33	8	4	K408180430
180	4:7.5	31.75	33	8	4	K408180431
180	4:7.5	35	33	8	4	K408180435
180	4:7.5	40	33	8	4	K408180440
180	4:7.5	50	33	8	4	K408180450



Ricambi / Spare parts / Rechanges / Repuestos / Ersatzteile



COD.

048020A000



COD.

048020B000



COD.

048020C000



COD.

048020D000



COD.

048020E000



COD.

048020F000

Adjustable grooving cutter head.

Porte - outils à rainier extensibles.

Cabezal para ranurar extensible.

Verstellbar Nutmesserkopf.

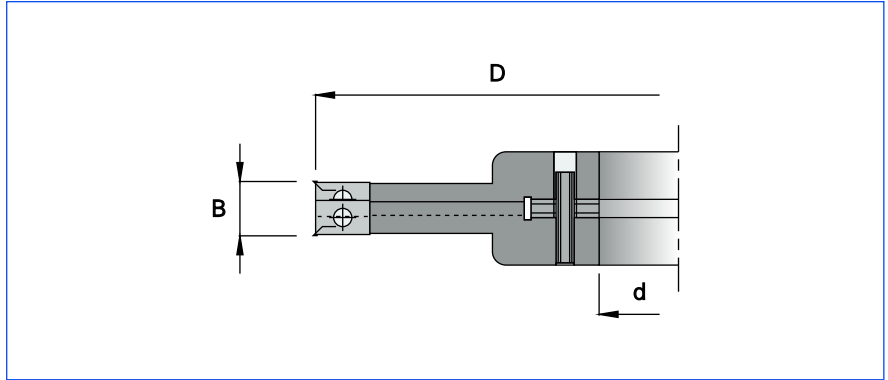

HW

MAN

D 140 n 5500 - 9500
 D 160 n 4800 - 8300
 D 250 n 3100 - 5300

D	B	d	T	Z	V	COD.
140	8 : 15.5	30	27	4	4	K408140830
140	8 : 15.5	31.75	27	4	4	K408140831
140	8 : 15.5	35	27	4	4	K408140835
140	8 : 15.5	40	27	4	4	K408140840
160	8 : 15.5	30	37	4	4	K408160830
160	8 : 15.5	31.75	37	4	4	K408160831
160	8 : 15.5	35	37	4	4	K408160835
160	8 : 15.5	40	37	4	4	K408160840
160	8 : 15.5	50	31	4	4	K408160850
250	8 : 15.5	30	63	4	4	K408250830
250	8 : 15.5	31.75	63	4	4	K408250831
250	8 : 15.5	35	63	4	4	K408250835
250	8 : 15.5	40	63	4	4	K408250840
250	8 : 15.5	50	63	4	4	K408250850

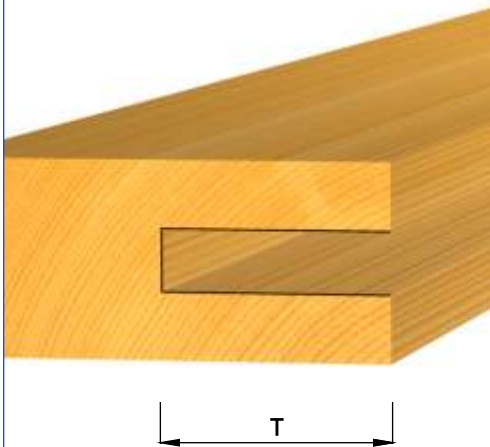

Ricambi / Spare parts / Rechanges / Repuestos / Ersatzteile



COD.

COD.

COD.

0480030014

0480050007

0480500700



COD.

COD.

COD.

048060A000

0480700512

048074A507

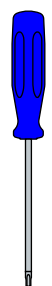
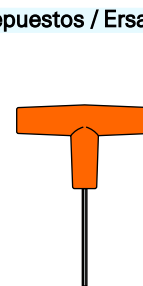

COD.

COD.

0480782500

048078T200



Adjustable grooving cutter head.



Cabezal para ranurar extensible.



Porte - outils à rainer extensibles.



Verstellbar Nutmesserkopf.

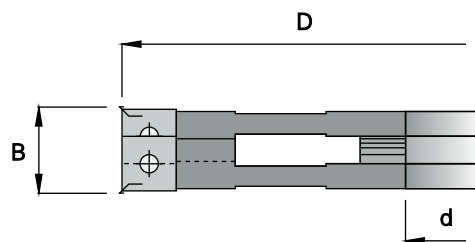

HW

MAN

D 140 n 5500 - 9500
 D 160 n 4800 - 8300
 D 250 n 3100 - 5300

D	B	d	T	Z	V	COD.
140	12.5:22	30	43	4	4	K408141230
140	12.5:22	31.75	43	4	4	K408141231
140	12.5:22	35	40	4	4	K408141235
140	12.5:22	40	38	4	4	K408141240
140	12.5:22	50	33	4	4	K408141250
160	12.5:22	30	53	4	4	K408161230
160	12.5:22	31.75	53	4	4	K408161231
160	12.5:22	35	50	4	4	K408161235
160	12.5:22	40	48	4	4	K408161240
160	12.5:22	50	43	4	4	K408161250
250	12.5:22	30	98	4	4	K408251230
250	12.5:22	31.75	98	4	4	K408251231
250	12.5:22	35	95	4	4	K408251235
250	12.5:22	40	93	4	4	K408251240
250	12.5:22	50	88	4	4	K408251250



Ricambi / Spare parts / Rechanges / Repuestos / Ersatzteile



COD.

0480030014



COD.

0480050012



COD.

0480501000



COD.

048060B000



COD.

0480700512



COD.

048074A510

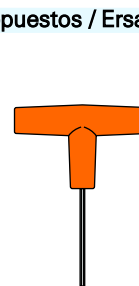

COD.

0480782500



COD.

048078T200

 Adjustable grooving cutter head.

 Cabezal para ranurar extensible.

 Porte - outils à rainier extensibles.

 Verstellbar Nutmesserkopf.