

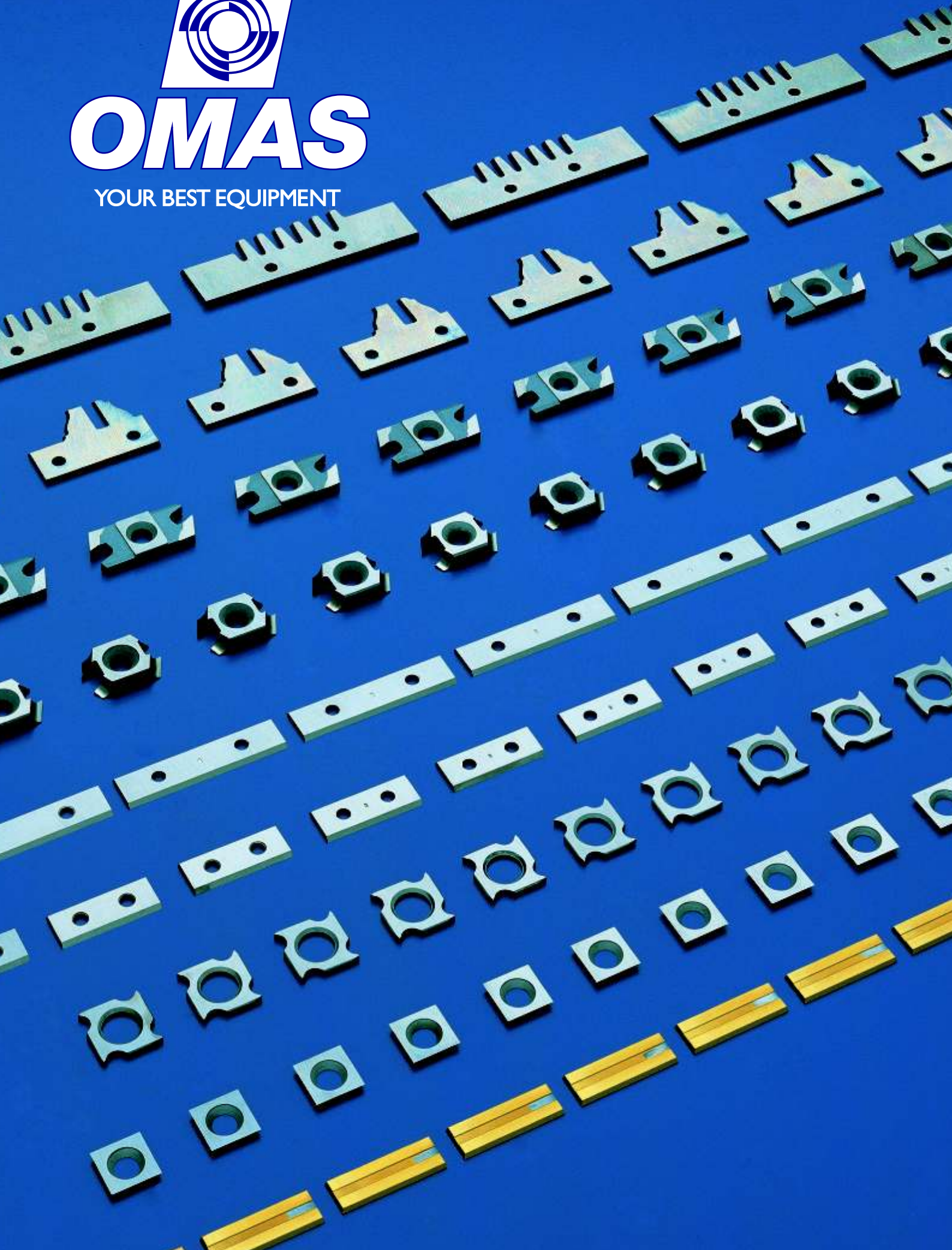

OMAS

YOUR BEST EQUIPMENT



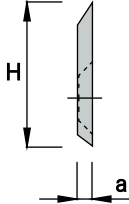
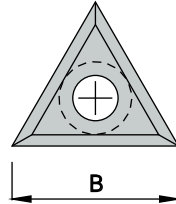

HW			B	H	a	COD.
			22	20	2	0480020000

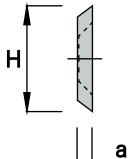
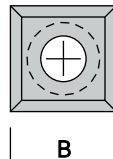
HW			B	H	a	COD.
			14	14	2	0480030014

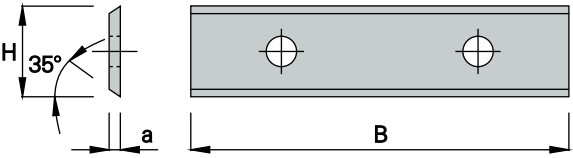
HW		B	H	a	COD.
		7.6	12	1.5	0480050007
		9	12	1.5	0480050009
		9.6	12	1.5	0480050096
		11	12	1.5	0480050011
		12	12	1.5	0480050012
		15	12	1.5	0480050015
		16	12	1.5	0480050016
		17	12	1.5	0480050017
		20	12	1.5	0480050020
		30	12	1.5	0480050030
		40	12	1.5	0480050040
		50	12	1.5	0480050050
		60	12	1.5	0480050060
		80	13	2.2	0480050080
		100	13	2.2	0480050100

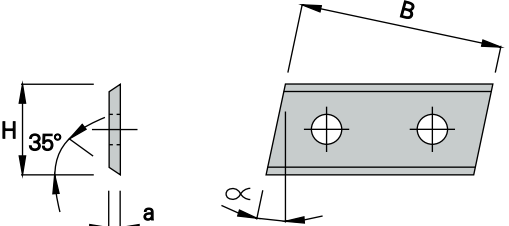
HW		B	H	α	a	COD.
		7.5	12	6°	1.5	0480070607
		9	12	6°	1.5	0480070609
		18.5	12	6°	1.5	0480070618
		28.5	12	6°	1.5	0480070628
		7.5	12	12°	1.5	0480071207
		9	12	12°	1.5	0480071209
		17	12	12°	1.5	0480071217
		26.8	12	12°	1.5	0480071226
		7.5	12	15°	1.5	0480071507
		9	12	15°	1.5	0480071509
		16	12	15°	1.5	0480071516
		25.8	12	15°	1.5	0480071525

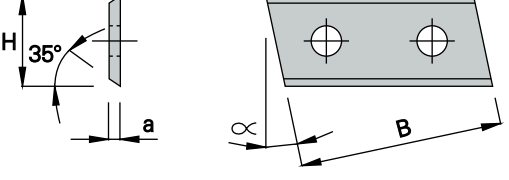
HW		B	H	α	a	COD.
		7.5	12	6°	1.5	0480080607
		9	12	6°	1.5	0480080609
		18.5	12	6°	1.5	0480080618
		28.5	12	6°	1.5	0480080628
		7.5	12	12°	1.5	0480081207
		9	12	12°	1.5	0480081209
		17	12	12°	1.5	0480081217
		26.8	12	12°	1.5	0480081226
		7.5	12	15°	1.5	0480081507
		9	12	15°	1.5	0480081509
		16	12	15°	1.5	0480081516
		25.8	12	15°	1.5	0480081525



HW

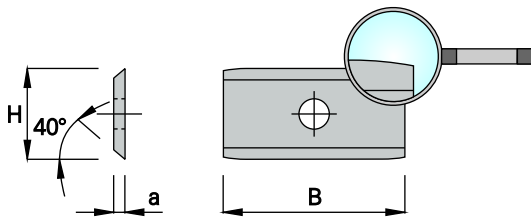

B	H	a	COD.
24	12	1.5	048015E240

HW

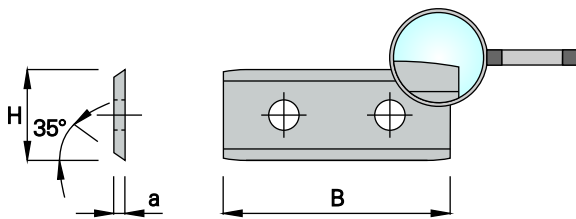

B	H	a	COD.
30	12	1.5	048015E300
50	12	1.5	048015E500

HW MICROGRANO
MICROGRAIN

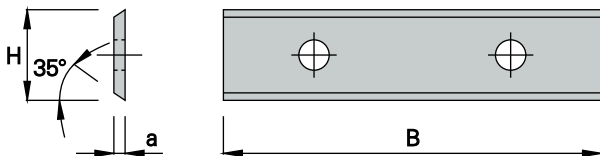

B	H	a	COD.
7.5	12	1.5	0480051007
12	12	1.5	0480051012
15	12	1.5	0480051015
20	12	1.5	0480051020
30	12	1.5	0480051030
50	12	1.5	0480051050
60	12	1.5	0480051060

HW PER LEGNI TENERI
FOR SOFT WOOD

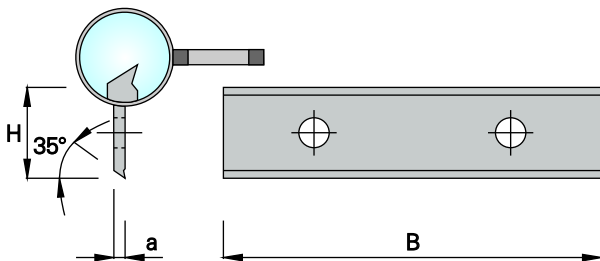

B	H	a	COD.
20	12	1.5	0480053020
30	12	1.5	0480053030
50	12	1.5	0480053050

HW PER LEGNI TENERI
FOR SOFT WOOD

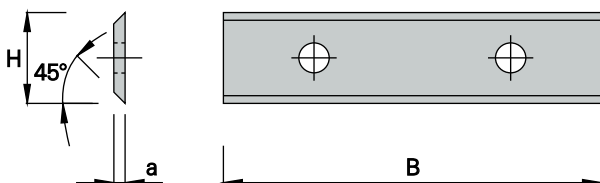

B	H	a	COD.
7,5	12	1.5	0480055007
12	12	1.5	0480055012
15	12	1.5	0480055015
20	12	1.5	0480055020
30	12	1.5	0480055030
40	12	1.5	0480055040
50	12	1.5	0480055050
60	12	1.5	0480055060



HW

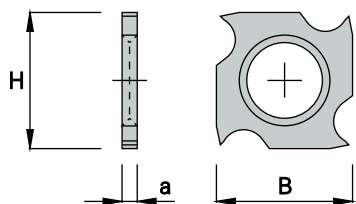

B	H	a	COD.
18	18	1.95	048020A000

HW

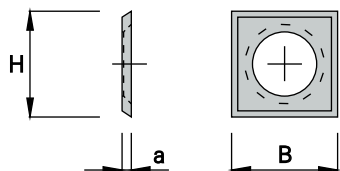

B	H	a	COD.
14	14	1.2	048020B000

HW

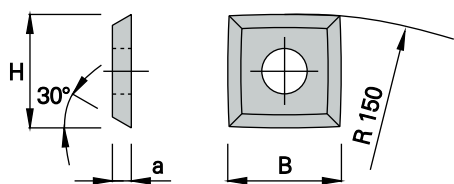

B	H	a	COD.
15	15	2.5	048125A000

HW

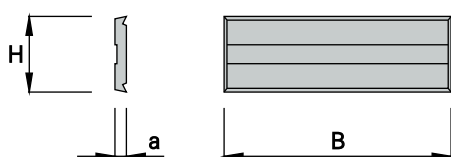

B	H	a	COD.
20	5.5	1.1	0517A00000
30	6.5	1.1	0517B00000
30	10	1.5	0517C00000



HW	B	H	a	COD.
	8.2	11	1.5	0519A00000
	9.2	11	1.5	0519B00000
	10.2	11	1.5	0519C00000
	11.2	11.2	1.5	0519D00000

HW	45°	R 1.5	R 3	R 5
	K480110000	K480130000	K480150000	K48015R500

HW	45°	R 1.5	R 3	R 5
	K480120000	K480140000	K480160000	K48016R500

HW	45°	R 2	R 3
	0480110000	0480120000	0480150000

HW	45°	R 2	R 3
	0480130000	0480140000	0480160000



HW 	B	COD.
	2.5	048019M000

HW 	B	COD.
	3	048019A000
	4	048019B000
	5	048019C000
	6	048019D000

HW 	B	COD.①	COD.②	COD.③
	3	048019A00I	048019A00S	048019A00T

HW 	B	COD.①	COD.②
	4	048019B00I	048019B00S
	5	048019C00I	048019C00S

HW 	B	COD.
	4	048019N000
	5	048019P000
	6	048019Q000



HW						Tipo	COD.
	A	B	C	D	A	K480183500	
					B	K48018R300	
					C	K480185700	
					D	K48018R400	

HW		B	COD.
		8	0480188400

HW		B	COD.
		5	048017R000

HW		B x P	ROT.	COD.
		3 x 6	RH	048017A0RH
		3 x 6	LH	048017A0LH
		4 x 8	LH	048017B000
		5 x 9	RH	048017C000
		4 x 8	RH	048017E000
		5 x 5	RH	048017F000
		3 x 8	RH	048017G000
		3 x 8	LH	048017H000
		4 x 12	RH	048017L100
		4 x 12	LH	048017L200

HW		A	B	C	Tipo	B	R	ROT.	COD.	
					A	4		RH	04801800RH	
					B	4		LH	04801800LH	
					C	6	3			048018R300
					C	8	4			048018R400



HW

B	COD.
3	K48017A000
4	K48017E000
5	K48017F000

HW

B	COD.①	COD.②
3	K48017A00I	K48017A00S
4	K48017E00I	K18017E00S
5	K48017F00I	K48017F00S

HW

B	COD.
4	K48017L000

HW

B	COD.①	COD.②
4	K48017L00I	K48017L00S

HW

B	COD.
4	048017LSL0